

Come Follow Me FHE

About This Download

PRINTING

Most of our downloads are formatted to print on 8.5x11" paper unless otherwise noted. You may print them at home or at a local print shop. We recommend using the latest version of Adobe Acrobat Reader to view and print your files. It is available for a free trial online.

If you experience issues with pages being cut off, select "Fit to Page" in your print dialog box to ensure the file prints correctly.

For larger page sizes (anything bigger than 8.5x11"), we recommend printing at a local print shop such as a UPS or FedEx store. Ask them to print your file as a black-and-white "engineer print" or "blueprint." These larger prints are big, fun, and fairly inexpensive.

If the print shop staff asks about your rights to reproduce this work, refer to the copyright release below. You can also tell them you downloaded these files for personal use from comefollowmefhe.com, and they can verify printing rights there.

COPYRIGHT RELEASE

By downloading this file, you agree that it is for personal use only. As the subscriber, you have the right to print this file as many times as needed for your family and Primary class (not your entire ward Primary).

You may not share this file with others or email it. Please use this file honestly. Redistributing, selling, or posting it online is strictly prohibited without prior permission from the author. If you are not the original subscriber, please purchase our materials before making copies.

For assistance, email us at info@comefollowmefhe.com



Cut apart each piece and staple together or hole punch and put on a binder ring.

Sacrifices for the Lord

Sacrifices in ancient times...

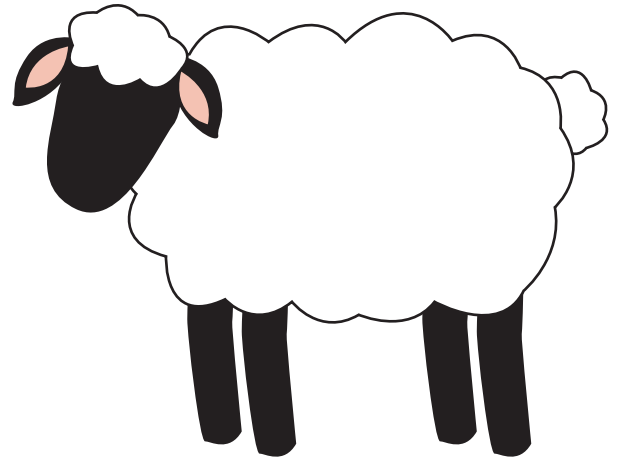

The Lord commanded His people to find firstborn lamb from their flock, and ensure it had no blemishes.

Sacrifices in ancient times...

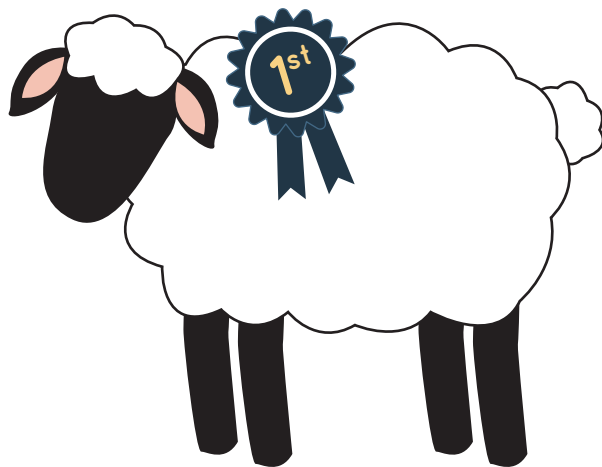

These were the Israelites' best lambs and it required a lot of obedience to follow this commandment.

Sacrifices in ancient times...

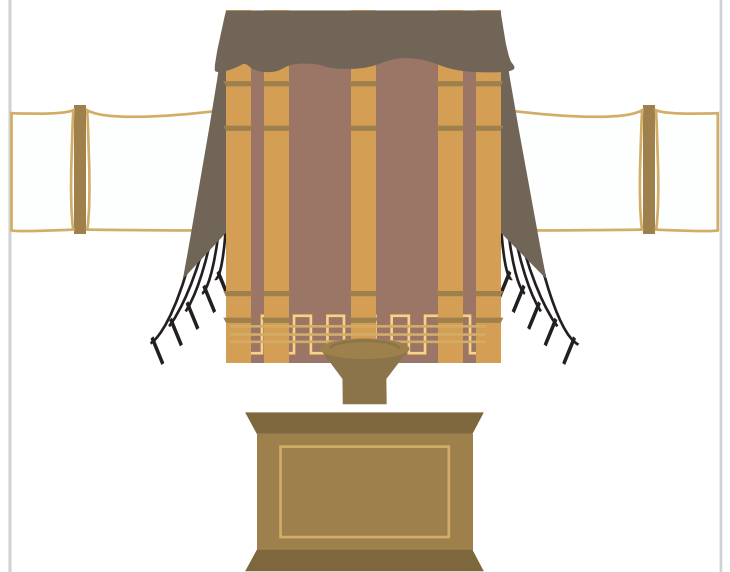

The people were commanded to take their lambs to the tabernacle to sacrifice them, to symbolize what Christ would do for each of us when He came to Earth.

Sacrifices in our day...

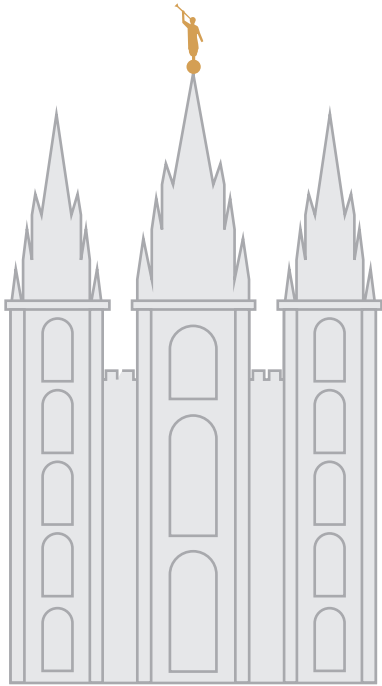

Today, we do not sacrifice in the same way the people did in ancient times...

Sacrifices in our day...

Because Jesus Christ has already come to Earth and made the ultimate sacrifice for each of us, we no longer

need to offer animal sacrifices. His sacrifice gives us the opportunity to repent, change, and strive to follow Him more closely.

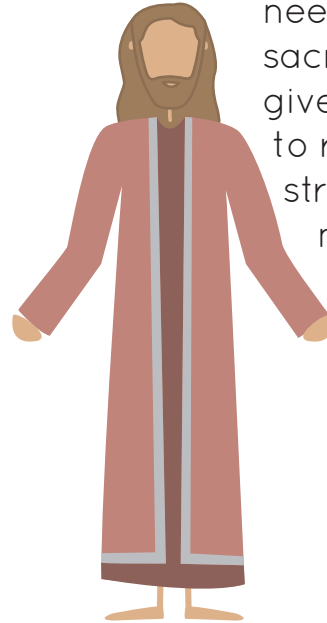

Sacrifices in our day...



Today, we are asked to sacrifice our broken hearts and contrite spirits to the Lord. He asks invites to follow Him.

What is a “broken heart” and “contrite spirit?”

A broken heart is when our hearts are open to the teachings and guidance of the Lord. It means we are humble, willing to make changes, and sacrifice to become better and more like Him.

A contrite spirit means we’re teachable, recognize when we make mistakes, and are repentant. We always strive to do better and remain humble.

Cut apart each piece and staple together or hole punch and put on a binder ring.

Sacrifices for the Lord

Sacrifices in ancient times...

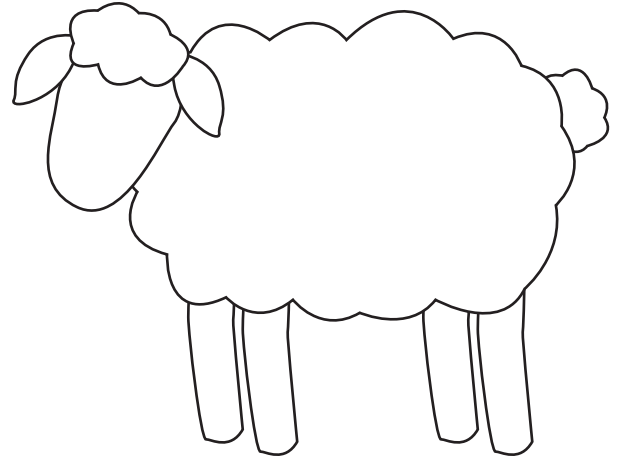

The Lord commanded His people to find firstborn lamb from their flock, and ensure it had no blemishes.

Sacrifices in ancient times...

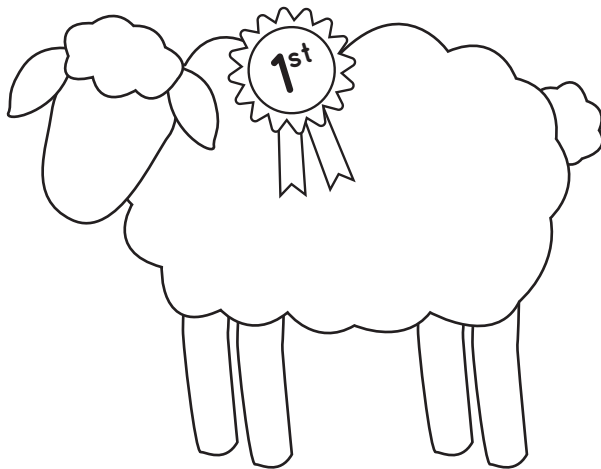

These were the Israelites' best lambs and it required a lot of obedience to follow this commandment.

Sacrifices in ancient times...

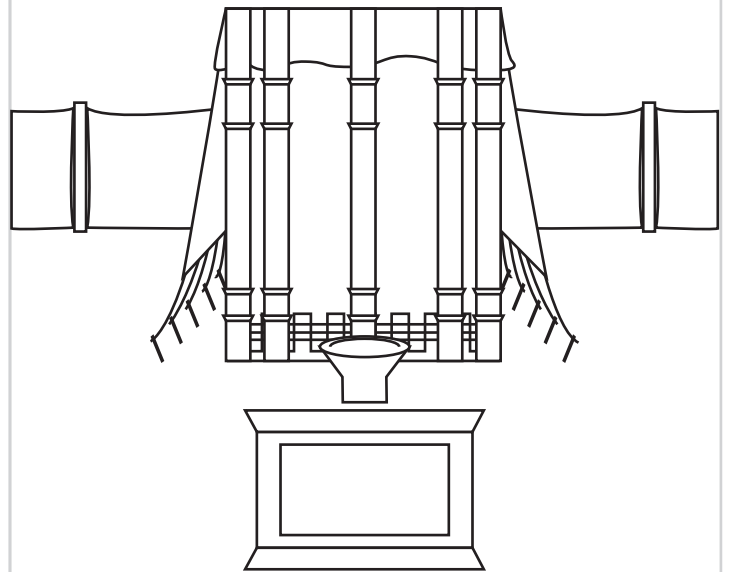

The people were commanded to take their lambs to the tabernacle to sacrifice them, to symbolize what Christ would do for each of us when He came to Earth.

Sacrifices in our day...

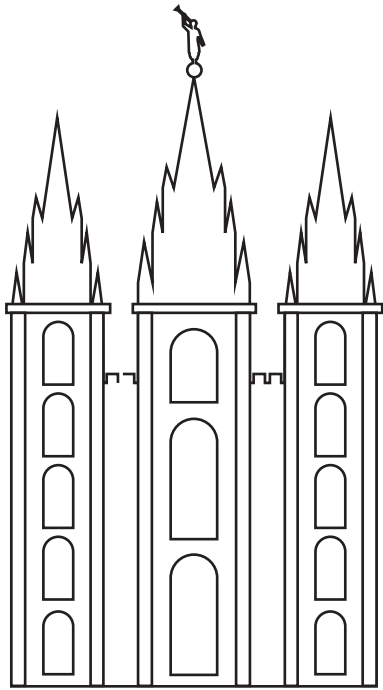

Today, we do not sacrifice in the same way the people did in ancient times...

Sacrifices in our day...

Because Jesus Christ has already come to Earth and made the ultimate sacrifice for each of us, we no longer

need to offer animal sacrifices. His sacrifice gives us the opportunity to repent, change, and strive to follow Him more closely.

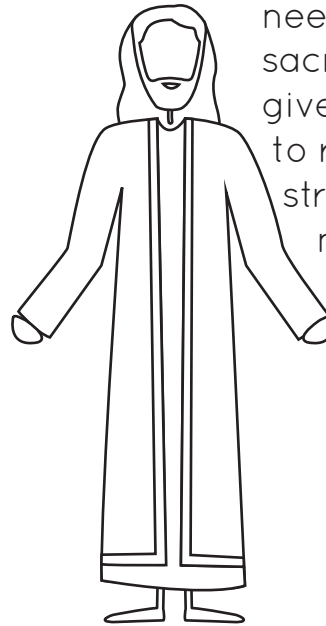

Sacrifices in our day...

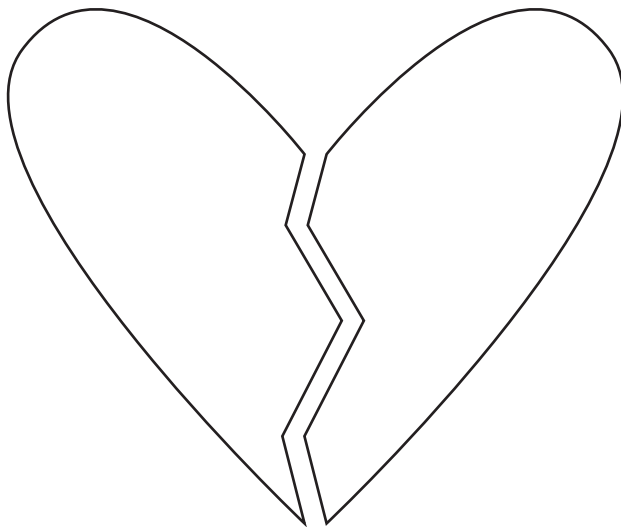

Today, we are asked to sacrifice our broken hearts and contrite spirits to the Lord. He asks invites to follow Him.

What is a “broken heart” and “contrite spirit?”

A broken heart is when our hearts are open to the teachings and guidance of the Lord. It means we are humble, willing to make changes, and sacrifice to become better and more like Him.

A contrite spirit means we’re teachable, recognize when we make mistakes, and are repentant. We always strive to do better and remain humble.